

## Stół przyścienny 001

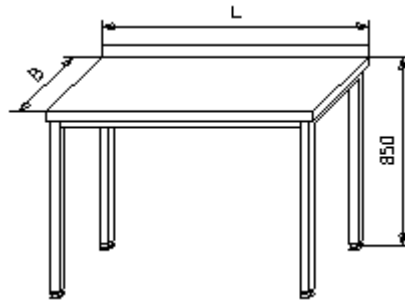

L	B	Cena netto	L	B	Cena netto
400	600	430	400	700	464
600	600	475	600	700	516
800	600	520	800	700	568
1000	600	565	1000	700	620
1200	600	610	1200	700	672
1400	600	655	1400	700	724

## Stół przyścienny 002

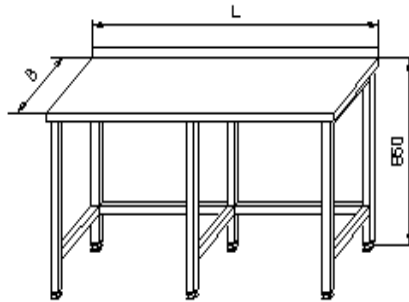

L	B	Cena netto	L	B	Cena netto
400	600	452	400	700	465
600	600	498	600	700	510
800	600	544	800	700	570
1000	600	590	1000	700	630
1200	600	636	1200	700	690
1400	600	682	1400	700	750
1600	600	728	1600	700	810
1800	600	774	1800	700	870
2000	600	895	2000	700	1005
2200	600	941	2200	700	1065
2400	600	987	2400	700	1125
2600	600	1033	2600	700	1185
2800	600	1079	2800	700	1245

**GASTRO-TECHNIKA**

### Stół przyścienny z półką 003

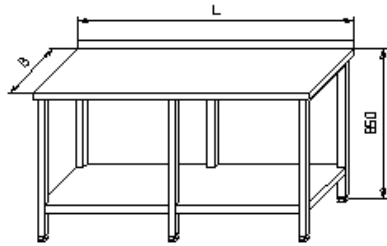

L	B	Cena netto	L	B	Cena netto
400	600	455	400	700	490
600	600	498	600	700	525
800	600	564	800	700	595
1000	600	630	1000	700	675
1200	600	696	1200	700	755
1400	600	762	1400	700	835
1600	600	828	1600	700	915
1800	600	894	1800	700	995
2000	600	1035	2000	700	1150
2200	600	1101	2200	700	1230
2400	600	1167	2400	700	1310
2600	600	1233	2600	700	1390
2800	600	1299	2800	700	1470

### Stół przyścienny narożny 004

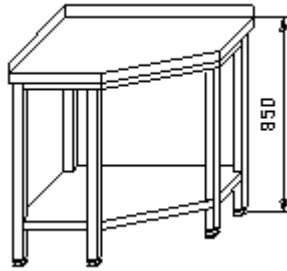

C	D	B1	B2	Cena netto
900	900	600	600	825
900	1000	600	700	870
1000	1000	700	700	916
1000	900	700	600	870

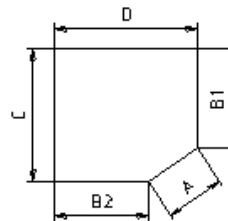

GASTRO-TECHNIKA

### Stół przyścienny z 2-ma półkami 005

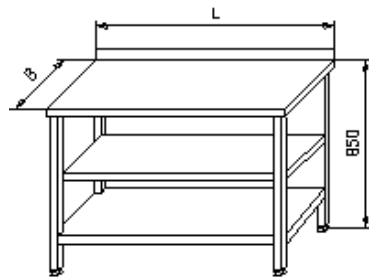

L	B	Cena netto	L	B	Cena netto
400	600	520	400	700	555
600	600	590	600	700	635
800	600	670	800	700	725
1000	600	760	1000	700	825
1200	600	850	1200	700	935
1400	600	940	1400	700	1045
1600	600	1030	1600	700	1155
1800	600	1120	1800	700	1265
2000	600	1285	2000	700	1450
2200	600	1375	2200	700	1560
2400	600	1465	2400	700	1670
2600	600	1555	2600	700	1780
2800	600	1645	2800	700	1890

### Stół centralny 006

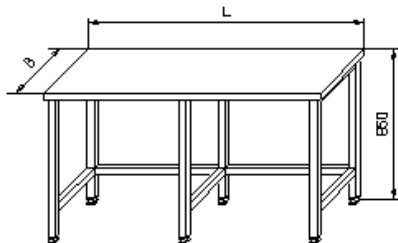

L	B	Cena netto	L	B	Cena netto
800	600	555	800	700	605
1000	600	615	1000	700	665
1200	600	675	1200	700	735
1400	600	735	1400	700	805
1600	600	795	1600	700	875
1800	600	855	1800	700	945
2000	600	990	2000	700	1090
2200	600	1050	2200	700	1190
2400	600	1110	2400	700	1230
2600	600	1170	2600	700	1300
2800	600	1230	2800	700	1370

GASTRO-TECHNIKA

### Stół przyścienny z drzwiami skrzydłowymi 007

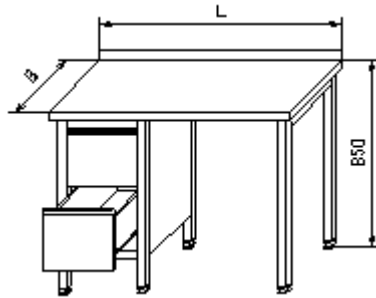

L	B	Cena netto	L	B	Cena netto
1000	600	1356	1000	700	1442
1200	600	1393	1200	700	1487
1400	600	1432	1400	700	1542
1600	600	1478	1600	700	1599
1800	600	1530	1800	700	1660

### Stół przyścienny z szufladami i półką 008

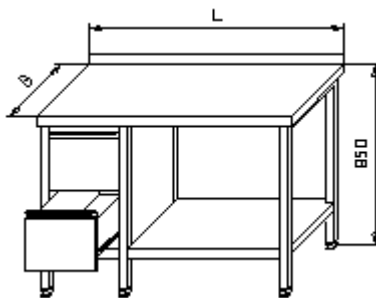

L	B	Cena netto	L	B	Cena netto
1000	600	1390	1000	700	1480
1200	600	1440	1200	700	1540
1400	600	1492	1400	700	1605
1600	600	1555	1600	700	1675
1800	600	1620	1800	700	1750

GASTRO-TECHNIKA

### Stół przyścienny zabudowany 009

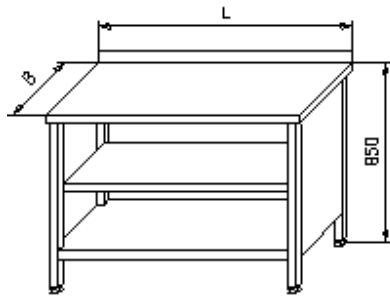

L	B	Cena netto	L	B	Cena netto
800	600	940	800	700	1040
1000	600	1020	1000	700	1120
1200	600	1120	1200	700	1220
1400	600	1220	1400	700	1320
1600	600	1320	1600	700	1420
1800	600	1420	1800	700	1520

### Stół przyścienny z drzwiami suwanymi 010

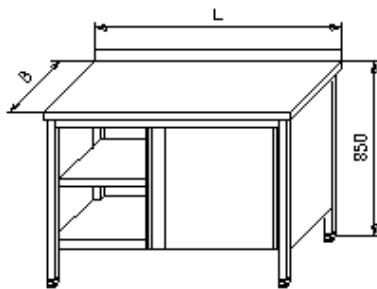

L	B	Cena netto	L	B	Cena netto
800	600	1320	800	700	1420
1000	600	1440	1000	700	1540
1200	600	1570	1200	700	1660
1400	600	1710	1400	700	1810
1600	600	1930	1600	700	2030
1800	600	2070	1800	700	2170

GASTRO-TECHNIKA

### Szafka wisząca otwarta 011

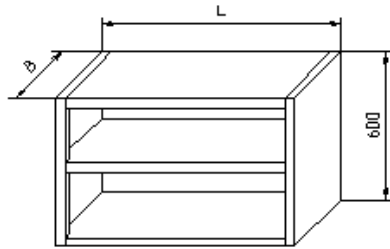

L	B	Cena netto	L	B	Cena netto
600	300	510	600	400	555
800	300	540	800	400	595
1000	300	580	1000	400	645
1200	300	630	1200	400	705
1400	300	680	1400	400	765
1600	300	730	1600	400	825
1800	300	780	1800	400	885

### Szafka wisząca z drzwiami skrzydłowymi 012

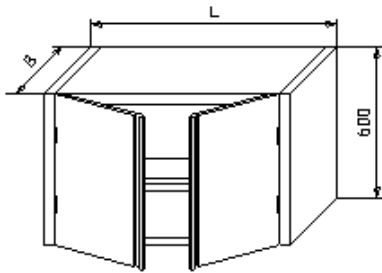

L	B	Cena netto	L	B	Cena netto
400	300	570	400	400	620
600	300	730	600	400	800
800	300	830	800	400	890
1000	300	930	1000	400	990
1200	300	1030	1200	400	1100

### Szafka wisząca z drzwiami suwanymi 013

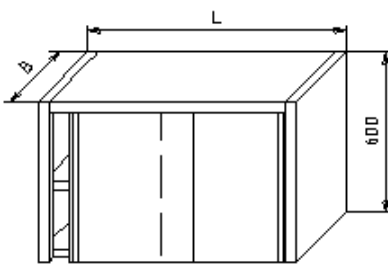

L	B	Cena netto	L	B	Cena netto
800	300	830	800	400	890
1000	300	930	1000	400	990
1200	300	1030	1200	400	1100
1400	300	1130	1400	400	1210
1600	300	1280	1600	400	1370
1800	300	1430	1800	400	1530

GASTRO-TECHNIKA

### Półka wisząca 014

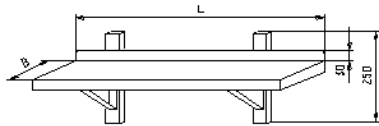

L	B	Cena netto	L	B	Cena netto
800	300	230	800	400	240
1000	300	245	1000	400	260
1200	300	260	1200	400	280
1400	300	275	1400	400	300
1600	300	315	1600	400	370
1800	300	355	1800	400	390

### Półka wisząca 015

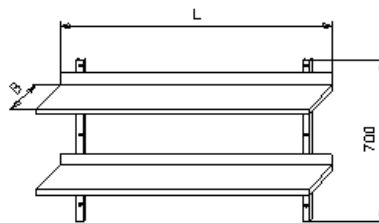

L	B	Cena netto	L	B	Cena netto
800	300	360	800	400	380
1000	300	390	1000	400	420
1200	300	440	1200	400	470
1400	300	480	1400	400	520
1600	300	575	1600	400	625
1800	300	615	1800	400	675

### Pojemnik jezdny na odpadki 016

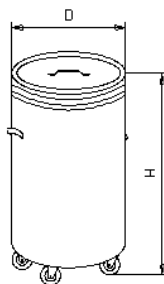

D	H	Cena netto
375	500	660
400	500	660

GASTRO-TECHNIKA

### Stół ze zlewem 017

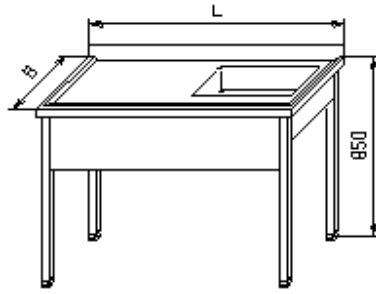

L	B	Cena netto	L	B	Cena netto
600	600	820	600	700	900
800	600	890	800	700	980
1000	600	960	1000	700	1060
1200	600	1030	1200	700	1140
1400	600	1100	1400	700	1220
1600	600	1200	1600	700	1310
1800	600	1300	1800	700	1400

### Stół ze zlewem i półką 018

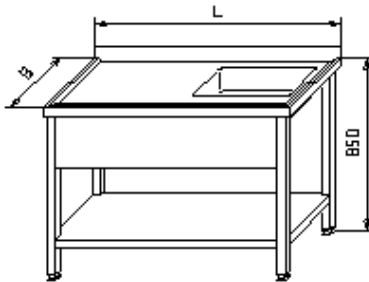

L	B	Cena netto	L	B	Cena netto
600	600	830	600	700	950
800	600	925	800	700	1060
1000	600	1020	1000	700	1170
1200	600	1115	1200	700	1280
1400	600	1210	1400	700	1390
1600	600	1305	1600	700	1500
1800	600	1400	1800	700	1610

GASTRO-TECHNIKA



## Stół ze zlewem i drzwiami suwanymi 019

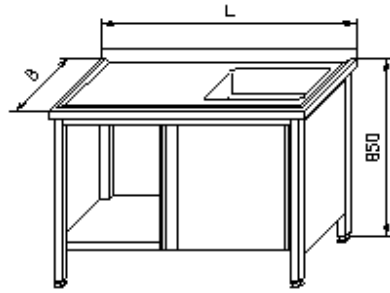

L	B	Cena netto	L	B	Cena netto
1000	600	1500	1000	700	1730
1200	600	1640	1200	700	1890
1400	600	1780	1400	700	2050
1600	600	2020	1600	700	2310
1800	600	2160	1800	700	2470

## Stół ze zlewem i drzwiami skrzydłowymi 020

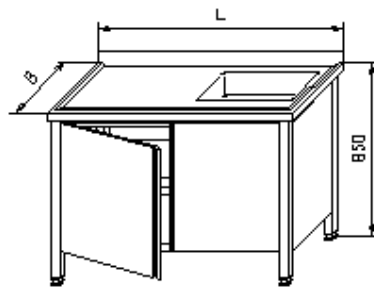

L	B	Cena netto	L	B	Cena netto
1000	600	1500	1000	700	1730
1200	600	1640	1200	700	1890
1400	600	1840	1400	700	2110
1600	600	2080	1600	700	2370
1800	600	2220	1800	700	2530

GASTRO-TECHNIKA

### Stół ze zlewem i szufladami 021

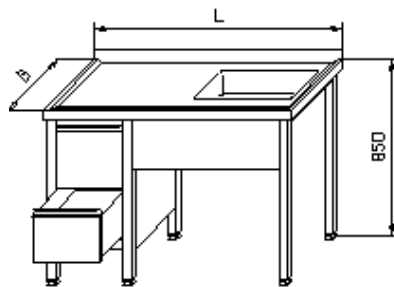

L	B	Cena netto	L	B	Cena netto
1000	600	1750	1000	700	1930
1200	600	1850	1200	700	2050
1400	600	1950	1400	700	2170
1600	600	2050	1600	700	2290
1800	600	2150	1800	700	2410

### Stół ze zlewem i drzwiami skrzydłowymi 022

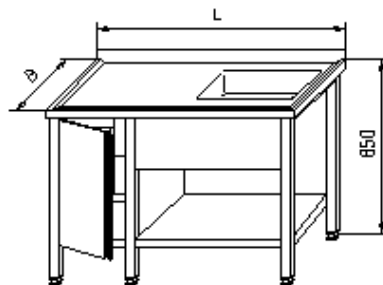

L	B	Cena netto	L	B	Cena netto
1000	600	1480	1000	700	1630
1200	600	1580	1200	700	1750
1400	600	1680	1400	700	1870
1600	600	1780	1600	700	1990
1800	600	1880	1800	700	2110

GASTRO-TECHNIKA

### Stół z 2-ma zlewami 023

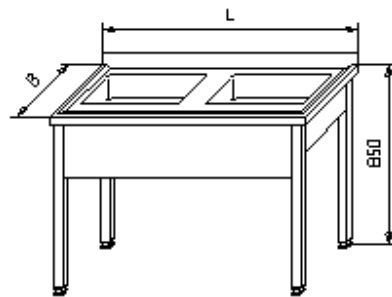

L	B	Cena netto	L	B	Cena netto
1000	600	1240	1000	700	1300
1200	600	1330	1200	700	1500
1400	600	1420	1400	700	1610
1600	600	1510	1600	700	1720
1800	600	1600	1800	700	1830

### Stół z 2-ma zlewami i półką 024

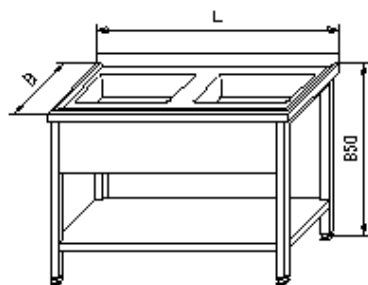

L	B	Cena netto	L	B	Cena netto
1000	600	1300	1000	700	1360
1200	600	1395	1200	700	1595
1400	600	1490	1400	700	1715
1600	600	1585	1600	700	1835
1800	600	1680	1800	700	1955

GASTRO-TECHNIKA

### Stół z 2-ma zlewami i drzwiami suwanymi 025

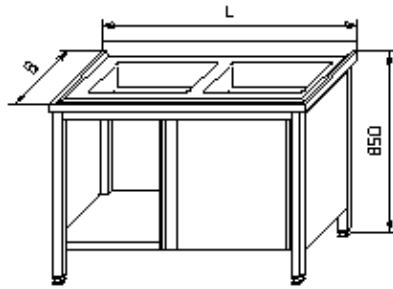

L	B	Cena netto	L	B	Cena netto
1000	600	1780	1000	700	1980
1200	600	1920	1200	700	2160
1400	600	2060	1400	700	2370
1600	600	2280	1600	700	2630
1800	600	2420	1800	700	2790

### Stół z 2-ma zlewami, szufladami i półką 026

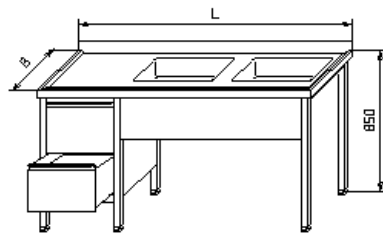

L	B	Cena netto	L	B	Cena netto
1400	600	2250	1400	700	2450
1600	600	2350	1600	700	2630
1800	600	2450	1800	700	2750
2000	600	2550	2000	700	2870
2200	600	2650	2200	700	2990
2400	600	2750	2400	700	3110

GASTRO-TECHNIKA

### Stół z 2-ma zlewami, szafką i półką 027

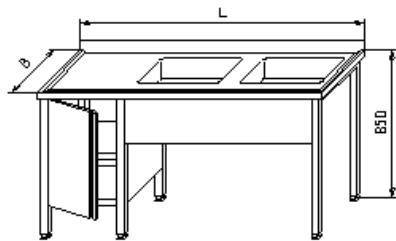

L	B	Cena netto	L	B	Cena netto
1400	600	2080	1400	700	2280
1600	600	2180	1600	700	2460
1800	600	2280	1800	700	2580
2000	600	2380	2000	700	2700
2200	600	2480	2200	700	2820
2400	600	2580	2400	700	2940

### Stół z 2-ma zlewami, otworem na odpadki i półką 028

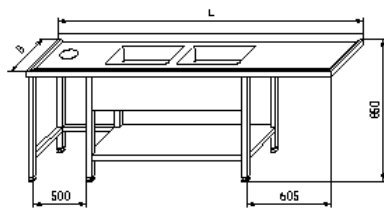

L	B	Cena netto	L	B	Cena netto
2200	600	2000	2200	700	2250
2400	600	2090	2400	700	2350

GASTRO-TECHNIKA

### Stół załadowniczy do zmywarki ze zlewem 029

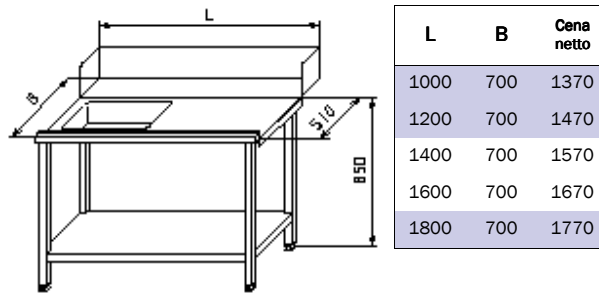

### Stół wyładowniczy do zmywarki 030

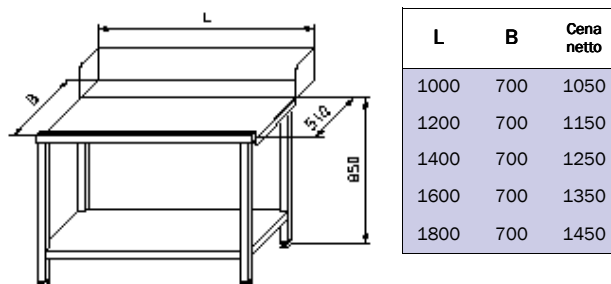

GASTRO-TECHNIKA

### Stół z basenem 031

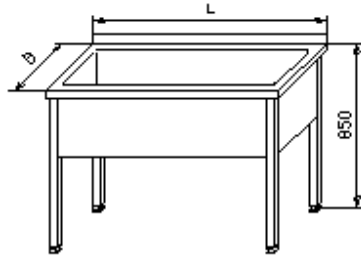

h=300			h=400		
L	B	Cena netto	L	B	Cena netto
800	600	1090	800	600	1160
1000	600	1180	1000	600	1260
1200	600	1270	1200	600	1360
800	700	1140	800	700	1220
1000	700	1240	1000	700	1330
1200	700	1340	1200	700	1440

### Stół z 2-ma zlewami, otworem na odpadki i półką 032

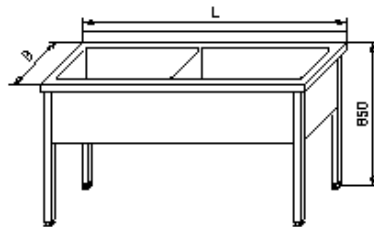

h=300			h=400		
L	B	Cena netto	L	B	Cena netto
1200	600	1370	1200	600	1470
1400	600	1470	1400	600	1580
1600	600	1570	1600	600	1690
1800	600	1670	1800	600	1800
1200	700	1430	1200	700	1540
1400	700	1540	1400	700	1660
1600	700	1650	1600	700	1780
1800	700	1760	1800	700	1900

GASTRO-TECHNIKA

### Podstawa pod zmywarę 033

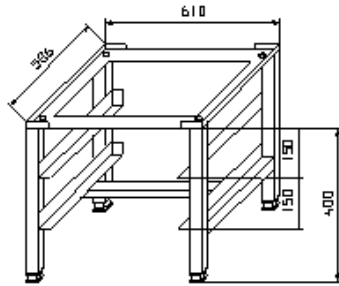

L	B	H	Cena netto
470	440	550	380
590	550	400	400
600	530	550	420

### Podstawa pod piec 034

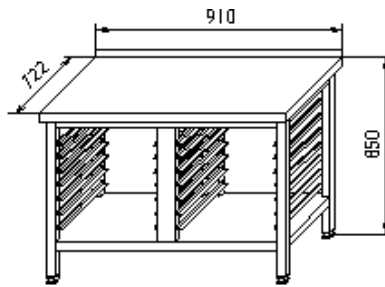

L	B	H	Cena netto
920	700	737	1100
950	720	800	1140
830	540	850	1020

### Podstawa pod piec 035

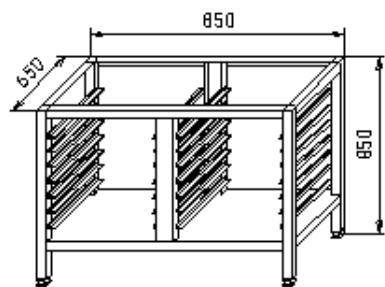

L	B	H	Cena netto
850	650	850	870
900	635	735	870
815	560	650	850
790	600	700	860
830	800	700	890
830	530	700	860

GASTRO-TECHNIKA



## Szafa magazynowa z drzwiami suwanymi 036

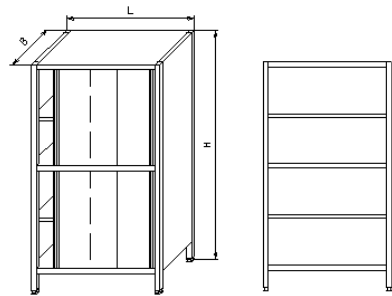

L	B	H	Cena netto	L	B	H	Cena netto
800	500	1800	2320	800	500	2000	2420
1000	500	1800	2550	1000	500	2000	2680
1200	500	1800	2780	1200	500	2000	2940
800	600	1800	2420	800	600	2000	2520
1000	600	1800	2670	1000	600	2000	2800
1200	600	1800	2920	1200	600	2000	3080

## Szafa przelotowa z drzwiami suwanymi 037

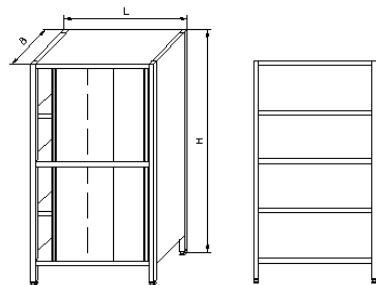

L	B	H	Cena netto	L	B	H	Cena netto
800	600	1800	2998	800	600	2000	3100
1000	600	1800	3350	1000	600	2000	3470
1200	600	1800	3680	1200	600	2000	3840
800	700	1800	3170	800	700	2000	3290
1000	700	1800	3500	1000	700	2000	3680
1200	700	1800	3830	1200	700	2000	4070

GASTRO-TECHNIKA

## Regał z półkami perforowanymi 038

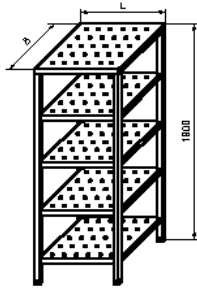

L	B	Cena netto	L	B	Cena netto
800	400	655	800	500	730
1000	400	725	1000	500	800
1200	400	795	1200	500	870

## Regał 039

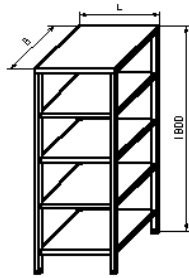

L	B	Cena netto	L	B	Cena netto
800	400	760	800	500	825
1000	400	820	1000	500	885
1200	400	880	1200	500	945

## Regał magazynowy gretingowi 040

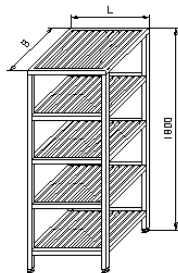

L	B	Cena netto	L	B	Cena netto
800	400	970	800	500	1010
1000	400	1030	1000	500	1110
1200	400	1090	1200	500	1210

GASTRO-TECHNIKA

## Okap przyścienny 041

- ceny z filtrami i króćcem

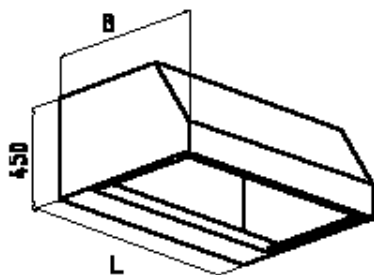

- w zamówieniu podać wielkość i rozmieszczenie króćców

L	B	Cena netto	L	B	Cena netto
1200	700	1590	1200	900	1860
1400	700	1730	1400	900	2000
1600	700	2060	1600	900	2340
1800	700	2200	1800	900	2490
2000	700	2340	2000	900	2640
2200	700	2680	2200	900	2980
2400	700	2820	2400	900	3120
2600	700	3160	2600	900	3460
2800	700	3290	2800	900	3610
3000	700	3420	3000	1000	3760
1200	800	1720	1200	1000	2020
1400	800	1860	1400	1000	2160
1600	800	2200	1600	1000	2500
1800	800	2340	1800	1000	2660
2000	800	2490	2000	1000	2810
2200	800	2820	2200	1000	3050
2400	800	2970	2400	1000	3290
2600	800	3300	2600	1000	3640
2800	800	3460	2800	1000	3780
3000	800	3620	3000	1000	3920

GASTRO-TECHNIKA

## Okap centralny 042

- ceny z filtrami i króćcem

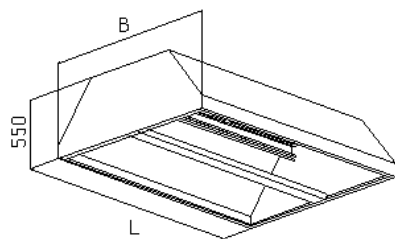

- w zamówieniu podać wielkość i rozmieszczenie króćców

L	B	Cena netto	L	B	Cena netto
1200	1200	2300	1200	1600	2660
1400	1200	2520	1400	1600	2900
1600	1200	3100	1600	1600	3480
1800	1200	3330	1800	1600	3700
2000	1200	3550	2000	1600	3930
2200	1200	4140	2200	1600	4530
2400	1200	4370	2400	1600	4770
2600	1200	4950	2600	1600	5370
2800	1200	5180	2800	1600	5580
3000	1200	5410	3000	1600	5890
1200	1400	2480	1200	1800	2850
1400	1400	2700	1400	1800	3100
1600	1400	3300	1600	1800	3700
1800	1400	3520	1800	1800	3900
2000	1400	3740	2000	1800	4140
2200	1400	4330	2200	1800	4750
2400	1400	4550	2400	1800	4970
2600	1400	5170	2600	1800	5570
2800	1400	5380	2800	1800	5800
3000	1400	5590	3000	1800	6030

## Oświetlenie

L	Moc	Cena netto
660	18W	220
12-70	36W	240

Ilość zamontowanych lamp w zależności od typu i długości okapu	Okapy przyścienne	Okapy centralne
L<1800	1x18W	2x18W
1800<2800	1x36W	2x36W

GASTRO-TECHNIKA